

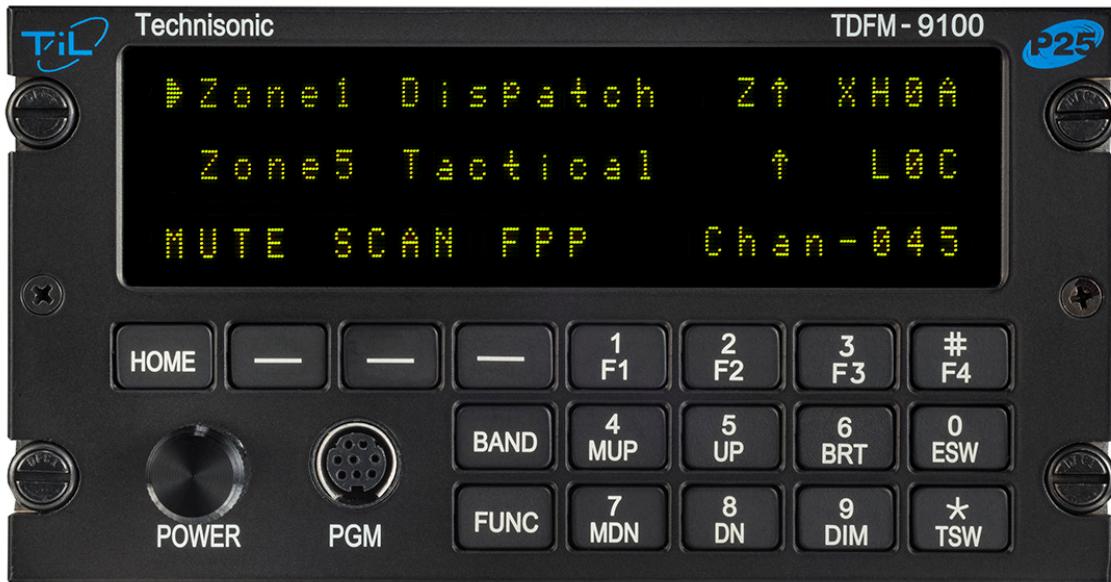

# TDFM-9100

MULTIBAND P25 AIRBORNE TRANSCEIVER



## Installation Instructions

TiL Document No. 13RE483  
Rev. C  
Issue 9

NOVEMBER 2015

---

### Technisonic Industries Limited

240 Traders Boulevard, Mississauga, Ontario L4Z 1W7  
Tel: (905) 890-2113 Fax: (905) 890-5338  
[www.til.ca](http://www.til.ca)

---

Copyright by Technisonic Industries Limited. All rights reserved.



**TECHNISONIC INDUSTRIES LIMITED**

<b>REVISION HISTORY</b> [ 13RE483 ]				
For the most current revision of this document, please check the Technisonic website: <a href="http://www.til.ca">www.til.ca</a>				
REV	PAGES	DESCRIPTION	DATE	EDITED BY
A		Added CI-295-300 Antenna.	Dec. 16, 2014	SM
A – 1	v 19 & 20 All All All	Table of Contents Corrected to match content. Sections 2.20 & 2.21 Mislabeled as 2.21 & 2.22. Relabeled Figures Sequentially & matched corresponding information. Changed Format for Section Headers. Corrected Spelling & Grammar throughout document.	Feb. 17, 2015	AL
B	iv & 32  All	Changes made to DO-160G: - Operational Shock and Crash Safety changed to Category B. - Flammability Condition added. Page Numbers are now sequential.	Sep. 10, 2015	AL
C	iv 32	Flammability Category C refers to Mod 6 only. Added NOTE-4 to Environmental Qualification Form.	Nov. 09, 2015	AL
C – 1	13 to 17	Updated Figures 4 – 8.	Feb. 24, 2016	AL
C – 2	All	Added band info on new Tri Band RF module.	Apr. 29, 2016	JR
C – 3	i 18 13 to 17	Added Website Information to Revision Page. Added Post Installation Adjustment. Updated Figures 4 – 8.	Oct. 05, 2016	AL
C – 4	11	Section 2.19: Clarified that the reference is to Section 2.17 of the Operating Instructions.	Nov. 30, 2016	AL
C – 5	22	Updated Test Frequencies	Feb. 13, 2018	SM
C – 6	All	Added connections to remote radios and Latitude S200-PTT satellite system (MOD 14).	May 3, 2018	SM
C – 7	i v All	Corrected Page Numbers. Updated Table of Contents. Corrected Spelling & Grammar throughout document.	Jul. 24, 2018	AL

**TECHNISONIC INDUSTRIES LIMITED**

<b>REVISION HISTORY</b> [ 13RE483 ]				
For the most current revision of this document, please check the Technisonic website: <a href="http://www.til.ca">www.til.ca</a>				
REV	PAGE	DESCRIPTION	DATE	EDITED BY
C – 8	All	Updated remote radio connections.	Jan. 25, 2019	SM
	All	S200-PTT is now S200-P12.		
	10	Updated Section 2.7 to reflect MOD 14 information.		
	10	Section 2.14: PTT band numbers added.		
	12	Section 2.25: Added List of Interface Cables.		
	15-16	Updated Wiring Connections diagrams.		
C – 9	3	Added Storage Temperature.	Oct. 10, 2019	AL

## NOTES

### **ESD CAUTION**



This unit contains static sensitive devices. Wear a grounded wrist strap and/or conductive gloves when handling printed circuit boards.

### **FCC COMPLIANCE INFORMATION**

This device complies with Part 15 of the FCC Rules. Operation is subject to the following two conditions: (1) this device may not cause harmful interference and (2) this device must accept any interference received, including interference that may cause undesired operation.



**WARNING:** For compliance with FCC RF Exposure Requirements, the mobile transmitter antenna installation shall comply with the following two conditions:

1. The transmitter antenna gain shall not exceed 3 dBi.
2. The transmitter antenna is required to be located outside of a vehicle and kept at a separation distance of 90 cm or more between the transmitter antenna of this device and persons during operation.

**NOTE:** This equipment has been tested and found to comply with the limits for a Class A digital device, pursuant to Part 15 of the FCC Rules. These limits are designed to provide reasonable protection against harmful interference when the equipment is operated in a commercial environment. This equipment generates, uses, and can radiate radio frequency energy and, if not installed and used in accordance with the instruction manual, may cause harmful interference to radio communications. Operation of this equipment in a residential area is likely to cause harmful interference, in which case the user will be required to correct the interference at his/her own expense.

### **WARNING AND DISCLAIMER**

Changes or modifications not expressly approved by Technisonic Industries could void the user's authority to operate the equipment.

This manual is designed to provide information about the TDFM-9100. Every effort has been made to make this manual as complete and accurate as possible.

### **WARRANTY INFORMATION**

The Model TDFM-9100 Transceiver is under warranty for one year from date of purchase. Failed units caused by defective parts or workmanship should be returned to:

Technisonic Industries Limited  
240 Traders Boulevard  
Mississauga, Ontario L4Z 1W7

Tel: (905) 890-2113  
Fax: (905) 890-5338

## TECHNISONIC INDUSTRIES LIMITED

### **SUMMARY OF DO-160G ENVIRONMENTAL TESTING**

Summary of DO-160G Environmental Testing for Technisonic Model TDFM-9100 Transceiver:

CONDITIONS	CATEGORY
Temperature and Altitude	A2, B1, C4, D1
Temperature Variation	B
Humidity	A
Operational Shock and Crash Safety	B
Vibration	S, U
Magnetic Effect	Z
Power Input	B
Voltage Spike	B
Audio Frequency Susceptibility	B
Induced Signal Susceptibility	AC
Radio Frequency Susceptibility	T
Radio Frequency Emission	M
Electrostatic Discharge	A
Flammability	C*

*\* Only applies to units with "MOD 6" marked on the modifications label.*

For more detailed information, see Appendix A.

### **INSTALLATION APPROVAL NOTE**

Presently, no TSO standard exists for airborne FM transceivers. To make it easier for installation agencies to provide their customers with an approved installation supported by an effective Airworthiness Approval, Technisonic has secured Supplemental Type Certificate (STC) Approvals on its Airborne FM products for a limited number of airframes. The above referenced DO-160G test data is also on file and available from Technisonic to support approval requirements in airframes for which Technisonic does not possess an STC.

Approved aircraft types are listed in the attachments to the formal STC documents. These STCs are the exclusive property of Technisonic and require the written authority of Technisonic for their use. Letters of permission are provided upon request. To assist Factory Authorized Technisonic Dealers in the certification process, we have placed copies of our STCs on our website. These documents may be downloaded and used as support for the technical submission to FAA or Transport Canada. Only authorized factory dealers/installers are permitted to download and make use of these documents on behalf of their customers (end users) in support of regulatory agency approval. Please refer to the Technisonic website [www.til.ca](http://www.til.ca) for the latest issue of available STCs.

### **TRADEMARK NOTICES**

TDFM-9100 Transceivers contain two-way radio protocols licensed from Motorola, Inc.

© 1997, 1998 Motorola, Inc.

Motorola KVL 3000+® is a registered trademark of Motorola.

**TABLE OF CONTENTS**

SECTION	TITLE	PAGE
<b>1</b>	<b>GENERAL DESCRIPTION</b>	
1.1	INTRODUCTION .....	1
1.2	DESCRIPTION .....	1
1.3	MODEL VARIATION .....	1
1.4	TECHNICAL CHARACTERISTICS .....	3
<b>2</b>	<b>INSTALLATION INSTRUCTIONS</b>	
2.1	GENERAL .....	5
2.2	EQUIPMENT PACKING LOG .....	5
2.3	INSTALLATION .....	5
2.4	INSTALLATION KIT - CONTENTS .....	5
2.5	ANTENNA INSTALLATION .....	5
2.6	INSTALLATION - PIN LOCATIONS AND CONNECTIONS .....	8
2.7	INSTALLATION - WIRING INSTRUCTIONS .....	10
2.8	MAIN GROUND – J1 PINS 1 AND 14 .....	10
2.9	MAIN POWER +28 V <sub>DC</sub> – J1 PINS 2 AND 15 .....	10
2.10	MIC 1 AND 2 – J1 PINS 3 AND 6 .....	10
2.11	MIC COMBINED – J1 PIN 9 .....	10
2.12	AUDIO 1 AND 2 – J1 PINS 4 AND 7 .....	10
2.13	AUDIO COMBINED – J1 PIN 10 .....	10
2.14	PTT 1 AND 2 – J1 PINS 5 AND 8 .....	10
2.15	PTT COMBINED – J1 PIN 11 .....	11
2.16	TX DATA AND RX DATA – J1 PINS 12 AND 13 .....	11
2.17	UP AND DOWN – J1 PINS 16 AND 17 .....	11
2.18	CHANNEL/BAND – J1 PIN 18 .....	11
2.19	PANEL BACKLIGHTING – J1 PIN 25 .....	11
2.20	MIC OUT 4 AND 5 – J2 PINS 1 AND 2 .....	11
2.21	AUDIO IN 4 AND 5 – J2 PINS 6 AND 7 .....	11
2.22	PTT OUT 4 AND 5 – J2 PINS 11 AND 12 .....	11
2.23	S200 DATA IN AND OUT – J2 PINS 4 AND 5 .....	11
2.24	DIGITAL AUDIO IN AND OUT – J2 PINS 9 AND 10 .....	11
2.25	SPEAKER LO AND HI – P1 PINS 8 AND 9 .....	12
2.26	POST INSTALLATION ADJUSTMENT .....	18
2.27	ANTENNA SELECTION AND INSTALLATION CONSIDERATIONS .....	19
2.28	POST INSTALLATION EMI TEST .....	20
	APPENDIX A Support Notes .....	31
	ENVIRONMENTAL QUALIFICATION FORM .....	31
	WARRANTY .....	34

## LIST OF FIGURES

FIGURE	TITLE	PAGE
1	Outline Drawing .....	6
2	TDFM-9100 Antenna & Connector Locations .....	7
3	TDFM-9100 Band Display Orientation .....	7
4	Wiring Connections for Separate Band Control .....	13
5	Wiring Connections for Combined Band Control .....	14
6	Wiring Connections for Separate and Combined Band Control .....	15
7	Additional Wiring Connections available with MOD 14 .....	16
8	Wiring Connection Notes for the TDFM-9100 Transceiver .....	17

## LIST OF TABLES

TABLE	TITLE	PAGE
1	J1 (25-Pin D) Connections .....	8
2	J2 (15-Pin D) Connections – MOD 14 Only .....	9
3	P1 (25-Pin D) Connections – MOD 14 Only .....	9
4	List of Interface Cables .....	12



## SECTION 1: GENERAL DESCRIPTION

### 1.1 INTRODUCTION

This publication provides operating information on the TDFM-9100 airborne transceiver. The exact configuration depends on which and how many RF modules are installed.

### 1.2 DESCRIPTION

The TDFM-9100 transceiver is an airborne multi-band radio capable of operation in conventional, analog FM, P25 digital systems, SmartNet/SmartZone trunking systems, and P25 9600 trunking systems. RF modules are available in single, dual, or tri bands that support various combinations of VHF, UHF-LO, UHF-HI, and 700-800 MHz bands. 1 or 2 single or multi band modules can be supported.

Optional additional features can include P25 9600 trunking Phase 1 and 2 that may be combined with AES and/or DES-OFB encryption with OTAR in any of the available modules.

The TDFM-9100 is not normally frequency agile. In order to have the ability to change the frequencies at the front panel, the FPP (front panel programming) option must be ordered for each band. FPP is available on all bands of modules.

When MOD 14 is incorporated, the TDFM-9100 can support the connection of one or two remote radios, generally portable handhelds that can be plugged in for special missions. Also supported is the Latitude S200-P12 satellite communications system. Control and display information is provided for the S200-P12 as well.

### 1.3 MODEL VARIATION

There are several variations of the Model TDFM-9100 Transceiver. Each variation offers different features and performance based on the type of RF modules and options installed.

The following is a breakdown of the TDFM-9100 model variations:

P/N 121270-D-91-TBB-P91XXX

(PRODUCT TYPE)-(D)-(91)-(Tray 1)-(Project)

PRODUCT TYPE: 121270 = TDFM-9100 series, 1 tray, 1 or 2 modules

D= Display type:

- 1) Standard Green LED
- 2) Night Vision Green LED

91 = TDFM-9100

## TECHNISONIC INDUSTRIES LIMITED

Tray Breakdown: (TBB):

T = Module type: A= T30xx RF modules (Single or Dual) or T4000 (Tri Band)

B = Band Code for each module in the tray. See the following table for supported configurations.

### TYPE A Module Band Codes

	DUAL BAND MODULES (T30xx)			TRI BAND MODULES (T4000)			
<b>SINGLE BAND</b>	1	VHF		5	VHF		
	2	UHF LO		6	UHF LO		
	3	UHF HI		7	UHF HI		
	4	700/800		8	700/800		
<b>DUAL BAND</b>	A	VHF	700/800	M	VHF	700/800	
	B	VHF	UHF LO	N	VHF	UHF LO	
	C	VHF	UHF HI	P	VHF	UHF HI	
	D	UHF LO	UHF HI	R	UHF LO	UHF HI	
	E	UHF LO	700/800	T	UHF LO	700/800	
	F	UHF HI	700/800	V	UHF HI	700/800	
	* G	700/800	VHF	-			
	* H	700/800	UHF LO	-			
	* I	700/800	UHF HI	-			
	* J	UHF LO	VHF	-			
	* K	UHF HI	VHF	-			
* L	UHF HI	UHF LO	-				
<b>TRI BAND</b>	-			W	VHF	UHF LO	UHF HI
	-			X	UHF LO	UHF HI	700/800
	-			\$ Z	VHF	UHF	700/800

### RF BAND COVERAGE

BAND	FREQUENCY RANGE
VHF	136 – 174 MHz
UHF LO	380 – 470 MHz
UHF HI	450 – 520 MHz
700/800	764 – 870 MHz
UHF	380 – 520 MHz

**NOTE:** There is only one P25 module tray in the TDFM-9100. If only one module is supplied in the tray, the second B digit will be a 0 in (TBB).

Band numbers indicate Single band equipped modules and letters indicate Dual or Tri band modules.

\* Band codes are special order and are not standard configuration.

\$ UHF Band specified covers both the UHF LO and UHF HI as one band. (380 – 520 MHz).

Project Number: P91XXX represents a 5-digit project number that identifies specific options that are contained in each module and describes the full TDFM-9100 configuration.

All model variations are capable of supporting both 28 Volt and 5 Volt AC or DC backlighting. The units are shipped set to operate on 28 Volt backlighting. Equipment can be set to operate on 5 V backlighting by using the software based configuration menu. See Section 2.17 Configuration Menu. Damage will not occur if the incorrect voltage is applied.

**TECHNISONIC INDUSTRIES LIMITED**

**1.4 TECHNICAL CHARACTERISTICS**

<u>Specification</u>	<u>Characteristic</u>
Model Designation:	TDFM-9100
Physical Dimensions:	Approx. (L) 8.0" x (W) 5.75" x (H) 3.0"
Weight:	~3.5 Lbs (1.6 Kg)
Operating Temperature Range:	-30° C to +60° C
Storage Temperature:	-40° C to +80° C
Power Requirement:	
Voltage:	28.0 V <sub>DC</sub> ± 15%
Current:	500 mA minimum / 5A maximum
Audio Output Power (including sidetone):	65 mW into 600 Ω
Microphone Inputs:	Carbon or Equivalent
Panel Back Lighting:	
Voltage:	28 or 5 Volts AC or DC (selectable)
Current:	100 mA max

**RF Modules**

<u>Specification</u>	<u>Characteristic</u>
RF Output Power:	1 or 6 Watts (VHF) 1 or 5 Watts (UHF) 1 or 2.5 Watts (764 – 806) 1 or 3 Watts (806 - 870)
Frequency Range	
VHF Band:	136 to 174 MHz
UHF LO Band:	380 to 470 MHz
UHF HI Band:	450 to 520 MHz
UHF Band:	380 to 520 MHz
700 / 800 bands:	764 to 870 MHz
No. of channels per band:	3000 pre-programmable channels

**Transmitter section**

	<b>VHF</b>	<b>UHF</b>	<b>800</b>
FM Hum and noise in dB (wideband):	-48	-45	-45
Audio Distortion:	1%	1.0%	1.0%
Frequency Stability in ppm:	±1.0	±1.0	±1.5
Modulation Limiting:	Wide band	±5 kHz	
	Narrow band	±2.5 kHz	

**Receiver section**

	<b>VHF</b>	<b>UHF</b>	<b>800</b>
<i>Sensitivity</i> in uV:			
*Digital 1% BER (12.5 kHz)	0.29	0.32	0.40
*Digital 5% BER (12.5 kHz)	0.21	0.28	0.30
**Analog with 12dB SINAD	0.25	0.25	0.25
<i>Selectivity</i> in dB:			
25 kHz Channel	-80	-78	-72
12.5 kHz Channel	-70	-68	-67
Intermodulation * **	-80	-80	-80

\* Measured in digital mode per TIA / EIA IS 102.CAAA under nominal conditions.

\*\* Measured in analog mode per TIA / EIA 603 under nominal conditions.

This page is intentionally left blank.

## SECTION 2: INSTALLATION INSTRUCTIONS

### 2.1 GENERAL

This section contains information and instructions for the correct installation of the TDFM-9100 Transceiver.

### 2.2 EQUIPMENT PACKING LOG

Unpack the equipment and check for any damage that may have occurred during transit. Save the original shipping container for returns due to damage or warranty claims. Check that each item on the packing slip has been shipped in the container.

### 2.3 INSTALLATION

The TDFM-9100 Transceiver is designed to be Dzus mounted and should be installed in conjunction with an IN-9100 installation kit. See Figure 1 for an outline drawing of the unit with dimensions to facilitate the installation.

### 2.4 INSTALLATION KIT - CONTENTS

The IN-9100 installation kit (P/N 139463-1) consists of:

1. One 25 pin Cannon D mating connector (female) complete with crimp pins and hood.
2. One 15 pin Cannon D HD mating connector (male) complete with crimp pins and hood.
3. One 15 pin Cannon D HD mating connector (female) complete with crimp pins and hood.
4. 2 BNC connectors (male).

### 2.5 ANTENNA INSTALLATION

The type and number of antennas depends on the model of transceiver being installed. See a complete list in Figure 5.

The antenna should be mounted on the bottom of the aircraft whenever possible. Consult with instructions provided with the antenna. Connect the RF cables to the back of the transceiver using the MALE BNC connectors provided in the installation kit. It is possible to use equivalent 50 ohm aviation antennas that cover the appropriate bandwidths. Also see Section 2.20 Antenna Selection and Installation Considerations.

TECHNISONIC INDUSTRIES LIMITED

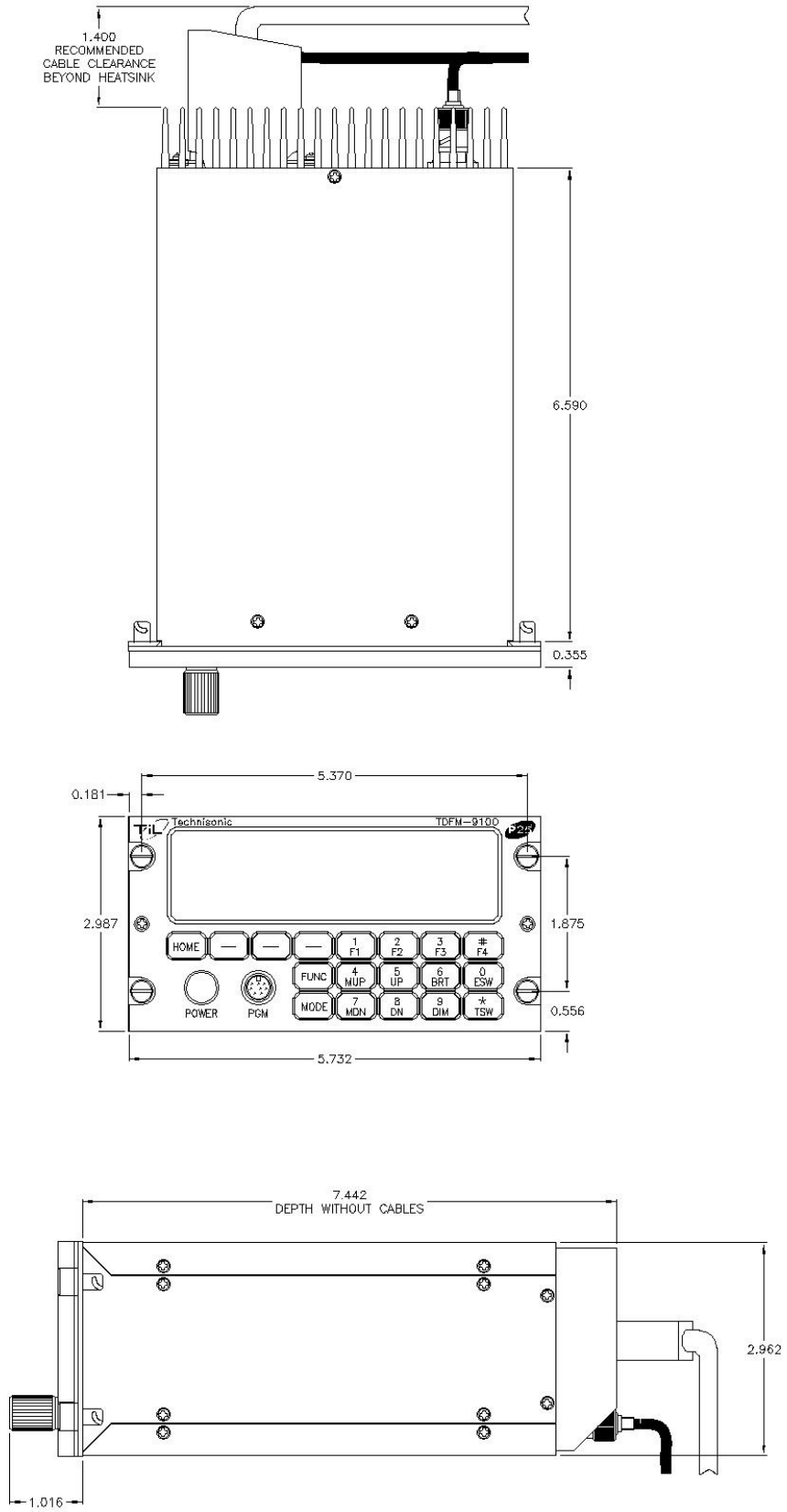

FIGURE 1: Outline Drawing for Model TDFM-9100

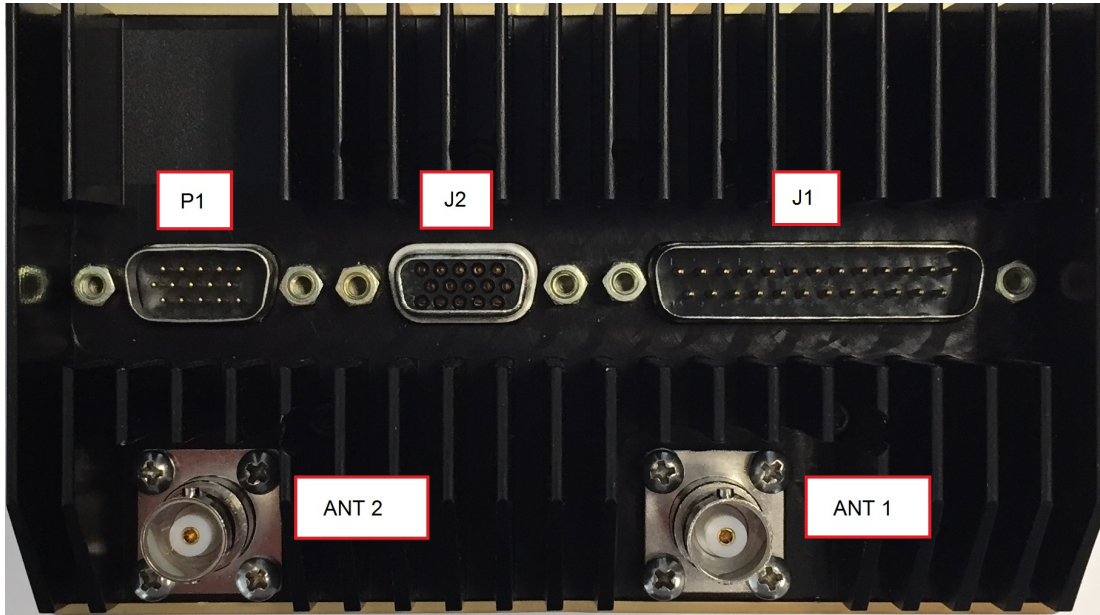

FIGURE 2: TDFM-9100 Antenna & Connector Locations (P1 and J2 on units with MOD 14 only)

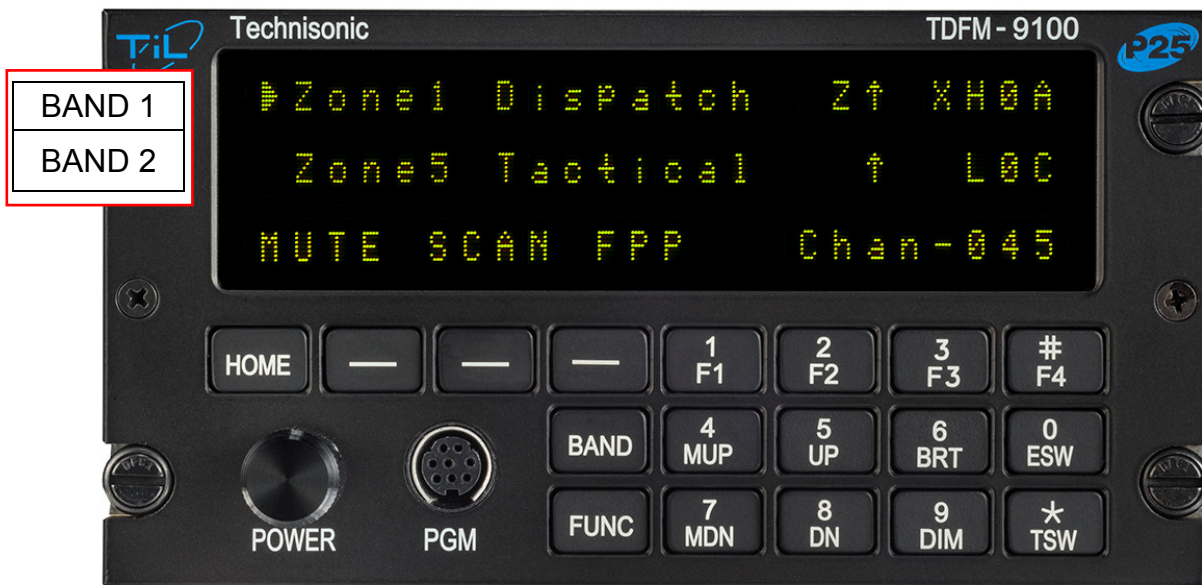

FIGURE 3: TDFM-9100 Band Display Orientation

**TECHNISONIC INDUSTRIES LIMITED**

**2.6 INSTALLATION - PIN LOCATIONS AND CONNECTIONS**

<b>J1 (25 Pin D) Connections - Use FEMALE Connector</b>	
<b>PIN #</b>	<b>DESCRIPTION</b>
1	Ground
2	Main Power +28 V <sub>DC</sub>
3	Mic 1
4	Audio 1
5	PTT 1
6	Mic 2
7	Audio 2
8	PTT 2
9	Mic Combined
10	Audio Combined
11	PTT Combined
12	RC-9100 TX Data
13	RC-9100 RX Data
14	Ground
15	Main Power +28 V <sub>DC</sub>
16	Up
17	Down
18	Channel / Band
19	Mic 4 *
20	Audio 4 *
21	PTT 4 *
22	Mic 5 *
23	Audio 5 *
24	PTT 5 *
25	Panel Backlighting

**TABLE 1:** J1 (25-Pin D) Connections (\* Denotes MOD 14 only)



**TECHNISONIC INDUSTRIES LIMITED**

<b>J2 (15 Pin D HD) Connections – MOD 14 Only - Use MALE Connector</b>	
<b>PIN #</b>	<b>DESCRIPTION</b>
1	Mic 4 Out Remote Radio 1
2	Mic 5 Out Remote Radio 2 / Latitude S200
3	Ground
4	Latitude S200 RX Data
5	Latitude S200 TX Data
6	Audio 4 In Remote Radio 1
7	Audio 5 In Remote Radio 2 / Latitude S200
8	Ground
9	Digital Audio In
10	Digital Audio Out
11	PTT 4 Out Remote Radio 1
12	PTT 5 Out Remote Radio 2 / Latitude S200
13	Vbus Remote Radio 1
14	USB D- Remote Radio 1
15	USB D+ Remote Radio 1

**TABLE 2:** J2 (15-Pin D HD) Connections – MOD 14 only

<b>P1 (15 Pin D HD) Connections – MOD 14 Only - Use FEMALE Connector</b>	
<b>PIN #</b>	<b>DESCRIPTION</b>
1	Ground
2	Main TX Data
3	PTT 3
4	No Connection
5	Audio 3
6	Mic 3
7	Main RX Data
8	Speaker LO
9	Speaker HI
10	No Connection
11	No Connection
12	No Connection
13	No Connection
14	No Connection
15	Ground

**TABLE 3:** P1 (15-Pin D HD) Connections – MOD 14 only

## 2.7 INSTALLATION - WIRING INSTRUCTIONS

Figures 4 – 8 show all required connections and recommended wire sizes for the TDFM-9100 transceiver. There are receive audio, mic audio, and PTT lines for each band as well as a set of lines combining both bands. The TDFM-9100 can be wired such that band selection can be made on the audio panel by wiring all bands individually to 2 (5 for MOD 14) separate positions on the audio panel. If enough positions are not available, the TDFM-9100 can be alternately wired into one position of the audio panel using the combined lines. In this case, band selection and audio monitoring is done on the TDFM-9100 front panel. An installation can be wired in a combination of both methods as all inputs and outputs are always active.

TDFM-9100 transceivers with MOD 14 have the capability to provide PTT, mic and headset for up to 2 (Bands 4 and 5), remote handheld transceivers, and/or a Latitude Technologies S200-P12 satphone / PTT network com transceiver. Connectors P1 and J2 provide the MOD 14 interface. See Table 4 for a list of recommended interface cables for various hand-held transceivers. MOD 14 also has provisions for an internal analog module (Band 3). A digital audio port has been added to interface with the Technisonic TDAP-650 and TDAP-750 digital audio panels.

## 2.8 MAIN GROUND – J1 PINS 1 AND 14

Both pins should be connected to power ground. These pins are internally connected to the chassis.

## 2.9 MAIN POWER + 28 V<sub>DC</sub> – J1 PINS 2 AND 15

Both pins should be connected to +28 volts DC +/- 15%.

## 2.10 MIC 1, 2, 3, 4 and 5 – J1 PINS 3, 6, P1 PIN 6, J1 PINS 19 AND 22

The microphone input signals shall be connected using shielded wire with the shield connected to ground (pin 1 or 14). For best results, it is recommended to leave the other end of the shield floating to prevent ground currents unless you are connecting to an audio panel with floating hi and lo inputs (for example the Technisonic A711 or A711L) in which case the shield must be connected to the lo input. These are individual inputs for each band.

## 2.11 MIC COMBINED – J1 PIN 9

The combined mic inputs should be wired and shielded as the individual mic inputs above. This mic input can be used for any band. Band selection is made at the TDFM-9100 front panel.

## 2.12 AUDIO 1, 2, 3, 4 AND 5 – J1 PINS 4, 7, P1 PIN 5, J1 PINS 20 AND 23

These are individual audio outputs from each band. All outputs are 600 ohms impedance. The output power is 600 mW maximum. Unused outputs do not have to be terminated and should be left unconnected.

## 2.13 AUDIO COMBINED – J1 PIN 10

This is combined audio output from any or all bands as selected from the front panel. The specifications are the same as the individual outputs above.

## 2.14 PTT 1, 2, 3, 4 AND 5 – J1 PINS 5, 8, P1 PIN 3, J1 PINS 21 AND 24

This refers to individual PTT lines for each band. These lines should be floating when in receive and grounded for transmit. The input has a pull up resistor to 5 volts. Connecting an audio panel that wishes to see more may result in no receive audio. Connect a 1N4006 diode in series with the cathode towards the audio panel in this case.

**2.15 PTT COMBINED – J1 PIN 11**

The combined PTT input to any or all bands as selected from the front panel. The specifications are the same as the individual inputs above.

**2.16 RC-9100 TX DATA AND RX DATA – J1 PINS 12 AND 13**

These pins provide RS-232 serial communications for use with the RC-9100 remote control head if installed. Consult the RC-9100 installation manual for details.

**2.17 UP AND DOWN – J1 PINS 16 AND 17**

These pins can be used to scroll up and down through the bands or channels for the band currently selected depending on the band input below. The inputs normally floating are grounded to activate. Two push buttons or a center off, SPDT, spring-loaded toggle switch are typically used on these inputs.

**2.18 CHANNEL/BAND – J1 PIN 18**

The Channel / Band input determines the function of the up down inputs above. If left unconnected, the up/down inputs are for channel selection. If grounded, the input is for band selection.

**2.19 PANEL BACKLIGHTING – J1 PIN 25**

Connect to aircraft panel dimming bus. The transceiver is capable of supporting 28 V<sub>AC/DC</sub> or 5 V<sub>AC/DC</sub> backlighting circuits. Select 28 volts or 5 volts via the Configuration Menu (see Section 2.17 of the TDFM-9100 Operating Instructions). No damage will occur if the wrong setting is selected.

**2.20 MIC OUT 4 AND 5 – J2 PINS 1 AND 2**

Transmit mic audio out to remote radio 1 and 2 / Latitude S200-P12. The output level is adjustable in the Maintenance Menu to meet the requirements of the remote radio.

**2.21 AUDIO IN 4 AND 5 – J2 PINS 6 AND 7**

Receive audio in from remote radio 1 and 2 / Latitude S200-P12. For best results, the remote handheld radio volume should be turned around half way up. No adjustment is needed with the S200-PTT.

**2.22 PTT OUT 4 AND 5 – J2 PINS 11 AND 12**

PTT out to remote radio 1 and 2 / Latitude S200-P12. This output is floating when unkeyed and pulled to ground for transmit.

**2.23 S200 DATA IN AND OUT – J2 PINS 4 AND 5**

RS232 data to and from the Latitude S200-P12 satellite communications system if connected.

**2.24 DIGITAL AUDIO IN AND OUT – J2 PINS 9 AND 10**

Digital audio to and from a digital audio panel such as the Technisonic TDAP-650 or TDAP-750. The data is in RS232 format. These pins can only be connected to one digital audio panel. Additional panels must use the analog connections.

**TECHNISONIC INDUSTRIES LIMITED**

**2.25 SPEAKER LO AND HI – P1 PINS 8 AND 9**

Optional 8 ohm speaker output. Connect to 8 ohm speaker or leave unconnected. No termination required when not used.

HAND HELD TRANSCEIVER MODEL	CABLE PART NUMBER
Motorola Moto-Turbo XPR-6300/6350/6500/6550, SRX-2200, APX-6000/7000/8000	179.6550
Motorola XTS-1500/2500/3000/5000, EFJ-5000, VP Series	179.0630
Harris / Ma/com Jaguar P5300/P5400/P7300, XG75	179.7370
Harris / Ma/com Unity XG-100, XL-200P	179.0641
Kenwood TK190/280/290/380/390/480/481/2140/3140/2180/3180/5210/5400	179.0136
Kenwood NX200, NX300	179.0136
Kenwood TK208/220/240D/248/250/260/270/308/320/340D/348/350/353/360/370/430/431272G/372G/3130/3131	179.6013
Icom F30/40/50/60/70/80	179.0160
Icom F3/3S/4/4S/4TR/10, IC-H2/H6/J12/M5/U12/U16	179.0737
Icom A6, F11/11S/14/21/21S/33GS/33GT/43GS/43GT/43TR	179.0748
Yeasu Vertex VX-500/510/520	179.0138
Yeasu Vertex VX-10/210/210A/131/160/180/300/400/410/420	179.0746
Bendix King Relm KNG P150, P400, P500, P800	179.0745
Sincgars PRC-117, MBITR	179.0600

**TABLE 4:** List of Interface Cables

**NOTE:** All the above cables interface the TDFM-9100 via a panel mounted locking DIN connector P/N 244.0070.

# TECHNISONIC INDUSTRIES LIMITED

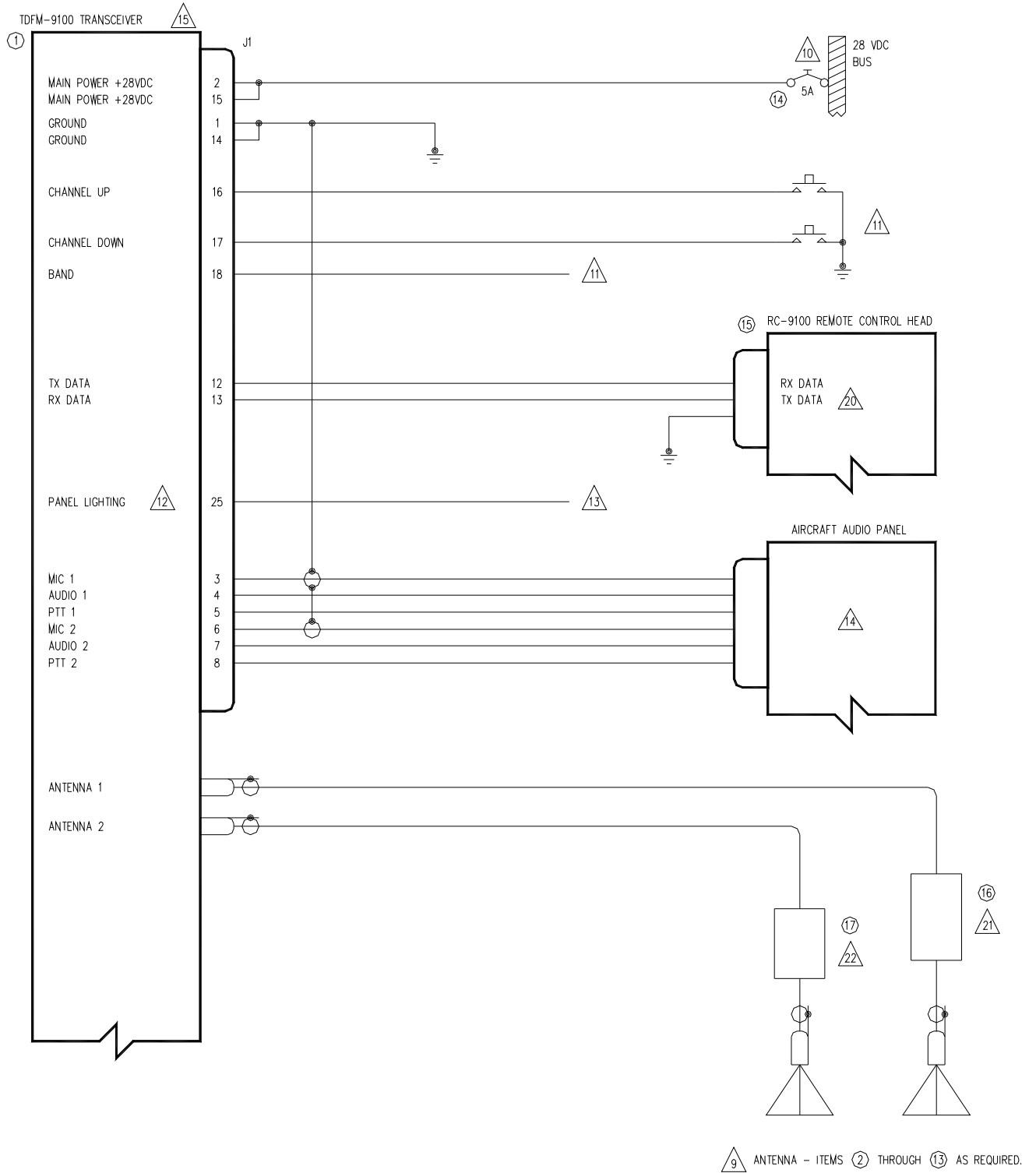

**FIGURE 4:** Wiring Connections for Separate Band Control

TECHNISONIC INDUSTRIES LIMITED

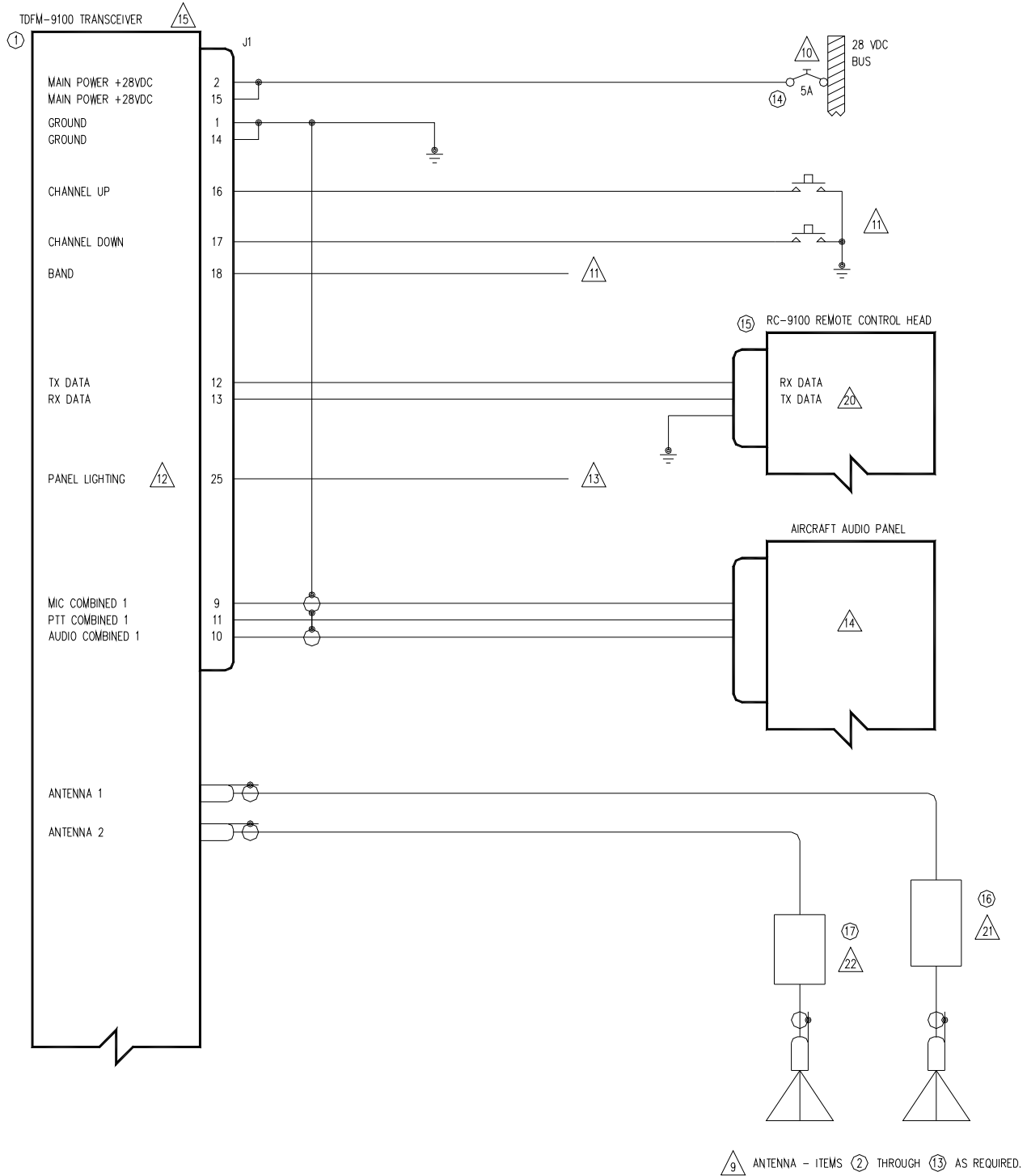

FIGURE 5: Wiring Connections for Combined Band Control

TECHNISONIC INDUSTRIES LIMITED

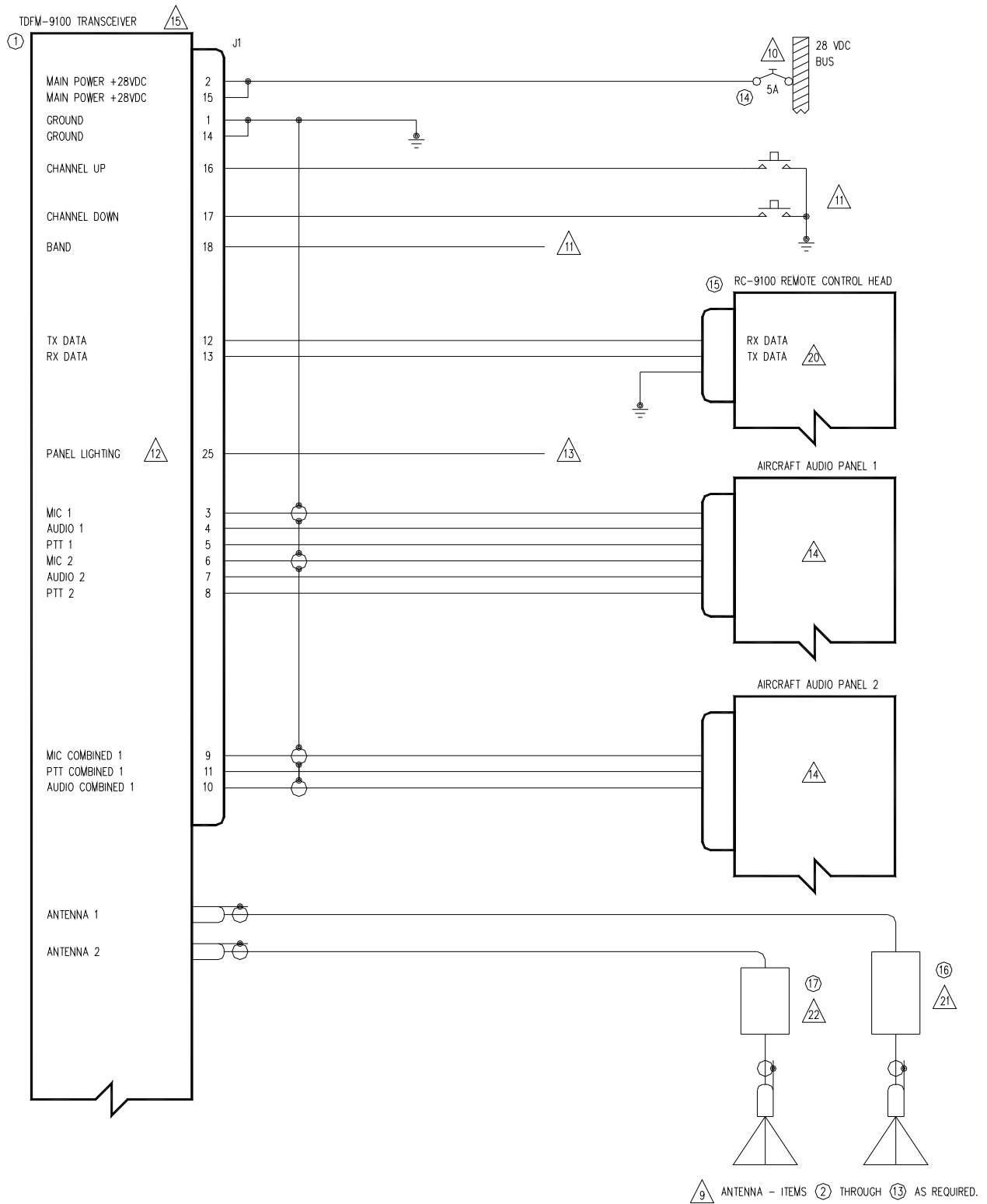

FIGURE 6: Wiring Connections for Separate and Combined Band Control

TECHNISONIC INDUSTRIES LIMITED

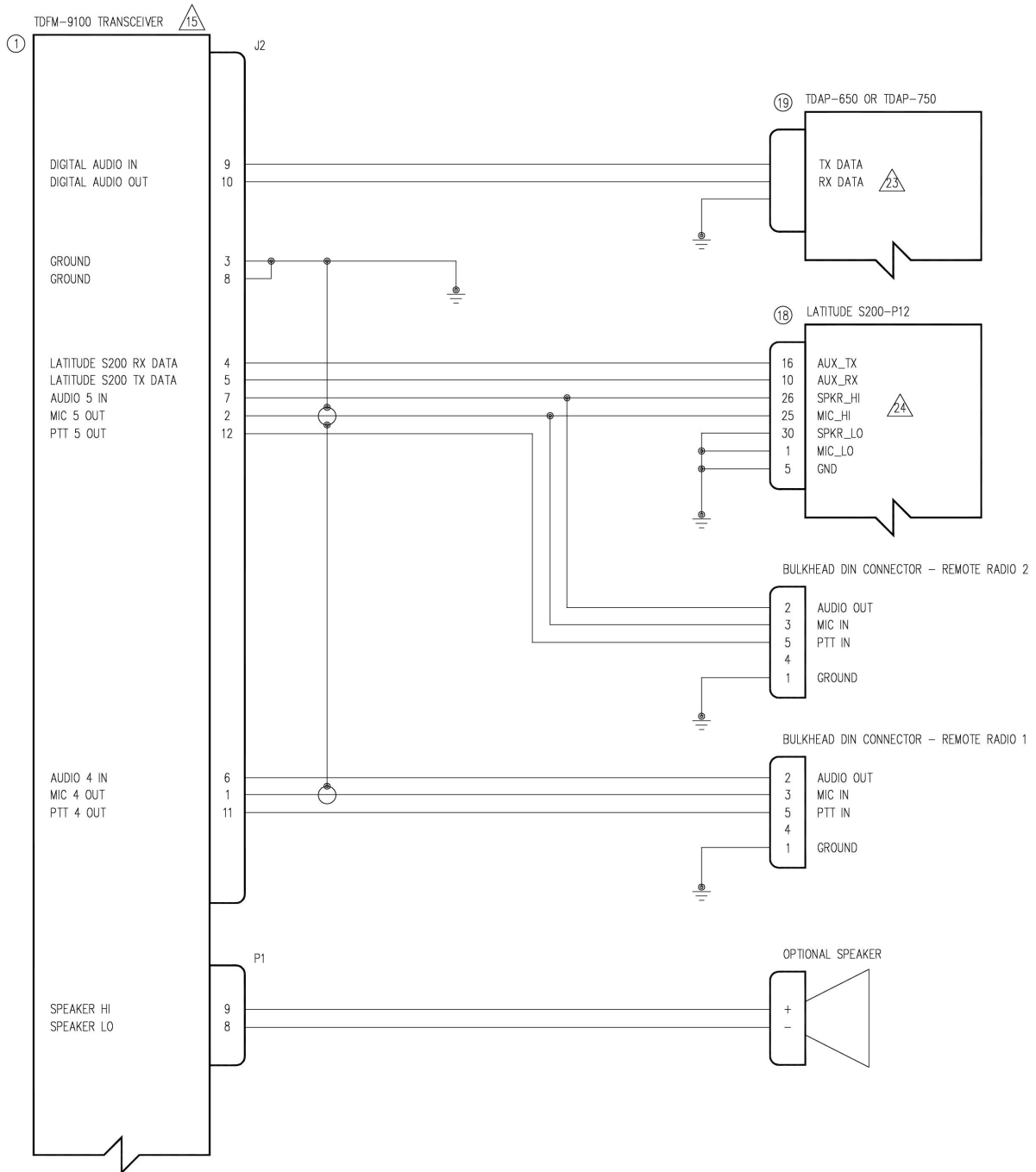

FIGURE 7: Additional Wiring Connections available with MOD 14

**NOTE:** Remote radio 2 interface and Latitude S200-P12 can not be installed at the same time as they use the same port.



## TECHNISONIC INDUSTRIES LIMITED

QTY	ITEM	PART NUMBER	DESCRIPTION	MANUFACTURER	MATERIAL
1	1	TDFM-9100	MULTIBAND FM COMMUNICATIONS TRANSCEIVER.	TECHNISONIC INDUSTRIES LIMITED	
A/R	2	CI-292-3	VHF ANTENNA, 136 TO 174 MHz	COMANT INDUSTRIES	
A/R	3	CI-292-4	VHF ANTENNA, 136 TO 174 MHz	COMANT INDUSTRIES	
A/R	4	CI-275	UHFLO ANTENNA, 403 TO 470 MHz	COMANT INDUSTRIES	
A/R	5	CI-275	UHFHI ANTENNA, 450 TO 512 MHz	COMANT INDUSTRIES	
A/R	6	CI-285	UHFHI (II) ANTENNA, 450 TO 520 MHz	COMANT INDUSTRIES	
A/R	7	CI-306	800 ANTENNA, 806 TO 870 MHz	COMANT INDUSTRIES	
A/R	8	CI-285	800/700 (II) ANTENNA, 700 TO 870 MHz	COMANT INDUSTRIES	
A/R	9	CI-295-200	VHF/UHF ANTENNA, 136 TO 174 / 380 TO 520 MHz	COMANT INDUSTRIES	
A/R	10	CI-295-250	VHF/700/800 ANTENNA, 136 TO 174 / 764 TO 870 MHz	COMANT INDUSTRIES	
A/R	11	21-50-45	VHF/UHF/700/800 ANTENNA, 136 TO 174 / 380 TO 870 MHz	COOPER ANTENNAS	
A/R	12	AV-925	VHF/UHF/700/800 ANTENNA, 136 TO 174 / 380 TO 520 / 760 TO 870 MHz	RAMI ANTENNAS	
A/R	13	CI-925-300	VHF/UHF/700/800 ANTENNA, 136 TO 174 / 380 TO 520 / 764 TO 870 MHz	COMANT INDUSTRIES	
1	14	7274-11-5	CIRCUIT BREAKER, 5 AMPS	KLIXON	
A/R	15	RC-9100	REMOTE CONTROL HEAD	TECHNISONIC INDUSTRIES LIMITED	
A/R	16	SRA-6000	SWITCHED RECEIVE ATTENUATOR	TECHNISONIC INDUSTRIES LIMITED	
A/R	17	133956-1	VHF HIGH PASS FILTER	TECHNISONIC INDUSTRIES LIMITED	
A/R	18	S200-P12	SATELLITE COMMUNICATIONS SYSTEM	LATITUDE TECHNOLOGIES	
A/R	19	TDAP-650 OR 750	DIGITAL AUDIO PANEL	TECHNISONIC INDUSTRIES LIMITED	

**NOTES:**

- 1) ALL WIRE IAW MIL-W-22759 UNLESS OTHERWISE SPECIFIED.
  - 2) ALL CABLE IAW MIL-C-27500 UNLESS OTHERWISE SPECIFIED.
  - 3) COAXIAL CABLE IAW MIL-C-17 UNLESS OTHERWISE SPECIFIED. DO NOT USE COAX WITH PVC INSULATION.
  - 4) FABRICATION & INSTALLATION OF WIRING HARNESS IAW AC 43.13-1B CHAPTER 11.
  - 5) GROUNDING AND BONDING IAW AC 43.13-1B CHAPTER 11, SECTION 15.
  - 6) ALL SINGLE WIRE TO BE #22 AWG MINIMUM AND ALL SHIELDED WIRE TO BE #24 AWG MINIMUM, UNLESS OTHERWISE SPECIFIED.
  - 7) POWER AND GROUND WIRES TO BE #20 AWG.
  - 8) ANTENNA COAX TO BE RG-142/U OR EQUIVALENT.
- 9) INSTALLATION OF ANTENNA IAW AC 43.13-1B CHAPTER 4, SECTION 4, CHAPTERS 6 & 7, AND AC 43.13-2A CHAPTER 3. IF POSSIBLE, THE ANTENNA SHOULD BE LOCATED A MINIMUM OF 12 FT FROM AIRCRAFT NAVIGATION RECEIVER ANTENNAS AND A MINIMUM OF 4 FEET FROM AIRCRAFT COMMUNICATIONS AND ELT ANTENNAS. BE CAREFUL NOT TO CHOOSE SEPARATIONS THAT CLOSELY APPROXIMATE 1/4 OR 1/2 OR WHOLE NUMBER MULTIPLES OF THE NAVIGATION OR COMMUNICATIONS WAVELENGTH.
- 10) AN EQUIVALENT CIRCUIT BREAKER OR FUSE MAY BE USED.
- 11) THE CHANNEL UP/DOWN AND BAND PUSH BUTTONS ARE OPTIONAL. LEAVE UNCONNECTED IF NOT USED.
- 12) THIS INPUT IS FOR BOTH 28 VDC AND 5 VAC PANEL LIGHTING. SELECT THE APPROPRIATE VOLTAGE IN THE CONFIGURATION MENU.
- 13) CONNECT TO THE APPROPRIATE AIRCRAFT DIMMING BUSS.
- 14) CONNECT TO THE AIRCRAFT AUDIO SYSTEM OR STAND-ALONE HEADSET JACKS.
- 15) INSTALLATION OF TRANSCEIVER IAW AC 43.13-1B CHAPTER 4, SECTION 4 AND AC 43.13-2A, CHAPTER 2. PR3 1/2 DZUS RAIL OR EQUIVALENT MAY BE USED.
- 16) TEST THE SYSTEM IN ACCORDANCE WITH THE POST-INSTALLATION TEST PROCEDURE IN THE INSTALLATION AND OPERATING INSTRUCTIONS MANUAL.
- 17) REFER TO THE AIRCRAFT STRUCTURAL REPAIR MANUAL AND THE MAINTENANCE MANUAL FOR INSTRUCTIONS AND INFORMATION PERTINENT TO THIS INSTALLATION.
- 18) NOTE REMOVED.
- 19) NOTE REMOVED.
- 20) CONNECTION TO AN OPTIONAL RC-9100 SLAVE CONTROL HEAD.
- 21) CONNECTION TO AN OPTIONAL SRA-6000 SWITCHED RECEIVE ATTENUATOR.
- 22) CONNECTION TO AN OPTIONAL VHF HIGH PASS FILTER.
- 23) CONNECTION TO AN OPTIONAL TDAP-650 OR TDAP-750 DIGITAL AUDIO PANEL.
- 24) CONNECTION TO AN OPTIONAL S200-P12 SATELLITE COMMUNICATIONS SYSTEM.

**FIGURE 8: Wiring Connection Notes for the TDFM-9100 Transceiver**

## 2.26 POST INSTALLATION ADJUSTMENT

In most cases, factory audio settings will work; however, if there is a need to adjust audio levels to match the audio controller system, then they can be adjusted in the Maintenance Menu.

To access the Maintenance Menu, press the FUNC key, then rotate the knob to point to MAINTENANCE. Press the knob to advance to the password page. Enter **1-5-9-3-5-7**.

This will bring up the first menu item. Pressing the knob will toggle through the menu items below and eventually return the radio to normal operation.

Menu items: (\* denotes MOD 14 only)

- A) **Mod 7** – This should be enabled if the radio has Mod #7 marked on the modification label. Rotate the knob to adjust between enable or disable.
- B) **Band 2** – Disable if RF module #2 is not installed. Rotate the knob to enable or disable.
- C) **Band 3\*** – Disable if multiband module is not installed. Rotate knob to enable or disable.
- D) **Band 4\*** – Disable if remote radio number 1 not used. Rotate knob to enable or disable.
- E) **Band 5\*** – Disable if remote radio number 2 is not used or Latitude S200-PTT is not connected. Rotate knob to enable or disable.
- F) **MIC 1 Level** – This menu sets the Mic gain for band 1. Key band 1 and rotate the knob to adjust the Mic gain to a desired level.
- G) **MIC 2 Level** – This menu sets the Mic gain for band 2. Key band 2 and rotate the knob to adjust the Mic gain to a desired level.
- H) **MIC 3 Level\*** – This menu sets the Mic gain for band 3. Key band 3 and rotate the knob to adjust the Mic gain to a desired level.
- I) **MIC 4 Level\*** – This menu sets the Mic gain for band 4. Key band 4 and rotate the knob to adjust the Mic gain to a desired level.
- J) **MIC 5 Level\*** – This menu sets the Mic gain for band 5. Key band 5 and rotate the knob to adjust the Mic gain to a desired level.
- K) **MIC Combined Level** – This menu sets the Mic gain for the Combined input. Key combined input for the selected RF module and rotate the knob to adjust the Mic gain to a desired level.
- L) **Band 1 RX Audio** – This sets the RX audio level from the Band 1 RF module. It is set at the factory, and field adjustment is not recommended.
- M) **Band 2 RX Audio** – This sets the RX audio level from the Band 2 RF module. It is set at the factory, and field adjustment is not recommended.
- N) **Initialize BT?\*** – Only required when new at the factory or if the Bluetooth module has been replaced. Press the YES or NO soft key.
- O) **Clone settings over BT to another TDFM-9100?\*** – Pressing the YES soft key will cause the TDFM-9100 to search for another TDFM-9100 over Bluetooth and update it with its settings. The other TDFM-9100 must be powered up and in the Maintenance Menu to be detected. Only maintenance and configuration settings can be cloned, not channel information.
- P) **Setup Digital Audio?\*** – Pressing the YES soft key allows you to assign bands in the TDFM-9100 to com positions in the TDAP-650 or TDAP-750 digital audio panel. Coms 3 through 8 on the panels are available for digital audio from the TDFM-9100. Any band or combined audio can be assigned in any order to any of the available audio panel com positions.

**2.27 ANTENNA SELECTION AND INSTALLATION CONSIDERATIONS**

Antenna installations will vary according to the number/type of bands installed in the TDFM-9100, types of antennas selected, and space available on the aircraft. The materials list above contains many but not all antennas available. If dual or tri band RF modules are installed in the TDFM-9100, it is suggested to use a single connector, multiband antenna for each of the RF modules installed. When single band modules are installed, a single band antenna should be used. If the TDFM-9100 has more than one single band module installed that are on different frequency bands, a single multiband antenna with separate connectors or a multiband antenna with a coupler can be used if the frequencies in use are not multiples of each other. For example, transmitting near 150 MHz on VHF may interfere with frequencies near 450 MHz on the UHF band. Antennas should be spaced as far as possible from each other with the Comm antennas on the opposite side (top or bottom) from the FM antennas.

## 2.28 POST INSTALLATION EMI TEST

### PURPOSE

The purpose of this test is to identify any interference that the TDFM-9100 transceiver may cause with existing aircraft systems.

### TEST CONDITIONS

The TDFM-9100 transceiver should be installed and function tested. The antenna VSWR should be checked. A forward/reverse power check with an in-line wattmeter should show no more than 10% reflected power. For the following tests, ensure that the output power is set to high.

### METHODOLOGY

Most of the EMI tests can be accomplished on the ground. In some cases, flight testing is required or is easier. If the aircraft is approved for IFR operations, then it is mandatory that interference between the TDFM-9100 transceiver and the approach aids be checked in flight.

The GPS should be operational and navigating with at least the minimum compliment of satellites. The VHF comm should be set to the frequencies indicated with the squelch open. VOR/DME receivers should be set to the frequencies indicated and selected for display. If possible, set up a DME ramp test set on the frequencies indicated and adjust the output until the flags are out of view. The transponder and encoder should be monitored with ramp test equipment. Set the output of the transponder test set to 3db above the output necessary to achieve 90% reply. If possible, set the ADF to a nearby navigation station.

Modulate the TDFM-9100 transmitter on the indicated frequencies for at least 20 seconds.

Observe the GPS for any degradation in satellite status or availability or flags. Listen for any noise or detected audio signals on the VHF comm(s). Listen for any noise or detected audio signals on the VOR/LOC receiver audio; look for any moment of flags or needles on the VOR/LOC/GS navigation display(s). Observe the transponder for any loss of reply or spurious reply.

List the power plant, fuel, and other electric instruments in the chart provided and note any anomalies that occur while transmitting. Assess the results.

If the aircraft is equipped with an autopilot or a stability augmentation system, then test fly the aircraft and verify that operation of the TDFM-9100 transceiver does not have adverse effects on these systems. After checking for gross effects at a safe altitude, fly an approach with each of the different navigation systems coupled to the autopilot (ILS, GPS, ETC.) and look for any anomalies.

## TECHNISONIC INDUSTRIES LIMITED

### RESULTS

If the installed system passes all of the applicable EMI tests, then no further action is required. If interference is observed, then the interference must be assessed against the appropriate standards of airworthiness for the system in question. For example, it is permissible for a VFR certified GPS to lose navigation capability while the TDFM-9100 unit is transmitting, providing that it recovers properly and promptly, but it is not permissible for an IFR Approach certified GPS to be affected in the same way. A complete discussion of all the standards of airworthiness to be applied in assessing EMI effects is beyond the scope of this document.

### PROCEDURE

- A. Operate the TDFM-9100 transmitter on the following frequency for at least 20 seconds. Observe the GPS for any degradation in satellite status or availability or flags.

FREQUENCIES	GPS #1		GPS #2	
	PASS	FAIL	PASS	FAIL
143.2125 MHz				
143.2250 MHz				
157.5375 MHz				
157.5500 MHz				
512.0000 MHz				

### NOTES:

**TECHNISONIC INDUSTRIES LIMITED**

- B.** Determine if the image frequency for the VHF Comm falls within the range of the TDFM-9100. If so, select a set of frequencies that will cause the TDFM-9100 to be set as close as possible to the image frequency. Any one of the many possible sets will suffice. Record those values in the spaces provided in the following chart. Modulate the TDFM-9100 transmitter on the following frequencies for at least 20 seconds. Listen for any noise or detected audio signals on the VHF comm.

Example - Bendix/King KY 196A:

The first IF frequency is 11.4 MHz. The L.O. is above the received frequency (high side injection); therefore, the image frequency is 22.8 MHz above the selected frequency. Set the KY 196A to 120.000 MHz and the TDFM-9100 to 142.8000 MHz.

FREQUENCIES		RESULTS	
VHF #1	TDFM-9100	PASS	FAIL
135.975	138.0000		
121.150	157.5000		
131.250	157.5000		
<b>Image:</b>			

FREQUENCIES		RESULTS	
VHF #2	TDFM-9100	PASS	FAIL
135.975	138.0000		
121.150	157.5000		
131.250	157.5000		
<b>Image:</b>			

**NOTES:**

**TECHNISONIC INDUSTRIES LIMITED**

- C.** Determine if the image frequency for the VOR/ILS Nav falls within the range of the TDFM-9100. If so, select two sets of frequencies that will cause the TDFM-9100 to be set as close as possible to the image frequency. Choose one set in the localizer frequency range and one in the VOR frequency range. Record those values in the spaces provided in the following chart. Modulate the TDFM-9100 transmitter on the following frequencies for at least 20 seconds. Listen for any noise or detected audio signals on the receiver audio; look for any moment of flags or needles on the navigation display.

FREQUENCIES		RESULTS	
VOR/ILS #1	TDFM-9100	PASS	FAIL
108.000	162.0000		
108.100	162.1500		
<b>Image:</b>			

FREQUENCIES		RESULTS	
VOR/ILS #2	TDFM-9100	PASS	FAIL
108.000	162.0000		
108.100	162.1500		
<b>Image:</b>			

**NOTES:**

## TECHNISONIC INDUSTRIES LIMITED

- D. The following procedure checks for second harmonic interference to the glide slope receiver from the TDFM-9100. All transceivers produce harmonics (multiples of the wanted frequency) and while the TDFM-9100 far exceeds FCC requirements, interference can still be experienced depending upon antenna position and separation. Furthermore, other equipment in the aircraft and the structure of the aircraft can generate harmonics where dissimilar metals make contact or where grounds are isolated, etc. This is also true of aircraft hangars; therefore, testing should be done outside away from any structures where possible.

With a portable glide slope generator, provide enough signal to firmly activate the indicator needle and hide all flags. Increase the signal level by 3 dB. Modulate the TDFM-9100 transmitter on the following frequencies for at least 20 seconds. Observe the Glide Slope displays. Look for any movement of flags or needles on the navigation display. If an interference condition is detected, then the installation will have to be flight tested according to the following procedure. Using the table below, determine the glide slope frequency based on the localizer frequency of the ILS to be used. Divide the glide slope frequency by 2 and program into the TDFM-9100. Fly the aircraft to intercept the localizer and glide slope (both needles centered) at 26 nm from the runway. Transmit on the TDFM-9100 for 10 seconds and watch for any deflections or flags. Repeat the test every 2 nm until the indicators are not affected. If the distance is greater than 18 nm, then a pass shall be recorded; otherwise, the TDFM-9100 shall be placarded "Do not transmit while on ILS approach."

<b>Localizer</b>	<b>Glide Slope</b>	<b>Localizer</b>	<b>Glide Slope</b>
108.10	334.70	110.10	334.40
108.15	334.55	110.15	334.25
108.30	334.10	110.30	335.00
108.35	333.95	110.35	334.85
108.50	329.90	110.50	329.60
108.55	329.75	110.55	329.45
108.70	330.50	110.70	330.20
108.75	330.35	110.75	330.05
108.90	329.30	110.90	330.80
108.95	329.15	110.95	330.65
109.10	331.40	111.10	331.70
109.15	331.25	111.15	331.55
109.30	332.00	111.30	332.30
109.35	331.85	111.35	332.15
109.50	332.60	111.50	332.90
109.55	332.35	111.55	332.75
109.70	333.20	111.70	333.50
109.75	333.05	111.75	333.35
109.90	333.80	111.90	331.10
109.95	333.65	111.95	330.95



**TECHNISONIC INDUSTRIES LIMITED**

FREQUENCIES		RESULTS	
G/S #1	TDFM-9100	PASS	FAIL
334.7 (108.1)	167.35		

FREQUENCIES		RESULTS	
G/S #2	TDFM-9100	PASS	FAIL
334.7 (108.1)	167.35		

**NOTES:**

- E. Operate the TDFM-9100 transmitter on the following frequency for at least 20 seconds. Observe the Transponder for any spurious replies or loss of reply to test set.

FREQUENCIES	TRANSPONDER #1		TRANSPONDER #2	
	PASS	FAIL	PASS	FAIL
512 MHz				

**NOTES:**

**TECHNISONIC INDUSTRIES LIMITED**

- F. Modulate the TDFM-9100 transmitter on the following frequencies for at least 20 seconds. Observe the DME displays. Look for loss of distance information on the display.

FREQUENCIES		RESULTS	
DME 1	TDFM-9100	PASS	FAIL
978 (108.0)	489		
1020 (112.1)	510		

FREQUENCIES		RESULTS	
DME 2	TDFM-9100	PASS	FAIL
978 (108.0)	489		
1020 (112.1)	510		

**NOTES:**

**TECHNISONIC INDUSTRIES LIMITED**

**G.** **NOTE:** For the following tests, select a frequency at the top, middle, and bottom of each band of the TDFM-9100 transceiver.

	136 to 174 MHz Band	403 to 470 MHz Band	450 to 512 MHz Band	806 to 870 MHz Band
Frequency #1				
Frequency #2				
Frequency #3				

**H.** At a safe altitude, engage the autopilot or stability augmentation system. Modulate the TDFM-9100 transmitter on the above frequencies for at least 20 seconds. Observe any effect on the autopilot or stability augmentation system.

Observations:

**I.** Perform a coupled ILS approach to the aircraft's certified limits. Modulate the TDFM-9100 transmitter on the above frequencies for at least 20 seconds. Observe any effect on the autopilot. Repeat for second flight director/autopilot if equipped.

Observations:

**TECHNISONIC INDUSTRIES LIMITED**

**J.** List the power plant, fuel, and other electric instruments in the chart provided and note any anomalies that occur while transmitting. Assess the results.

<b>STEP</b>	<b>SYSTEM</b>	<b>PASS</b>	<b>FAIL</b>	<b>NOTES</b>
1	Com 1 & 2 (UHF Lo, UHF Hi, and 800 MHz)			
2	Transponder & Encoder (VHF, UHF Lo, and 800 MHz)			
3	ADF 1 & 2			
4	VG			
5	Glideslope 1 & 2 (UHF Lo, UHF Hi, and 800 MHz)			
6	VOR/LOC 1 & 2 (UHF Lo, UHF Hi, and 800 MHz)			
7	Compass			
8	Directional Gyro			
9	Fuel Pressure			
10	Oil Temp			
11	Amps			
12	Bus Voltage			

**TECHNISONIC INDUSTRIES LIMITED**

<b>STEP</b>	<b>SYSTEM</b>	<b>PASS</b>	<b>FAIL</b>	<b>NOTES</b>
13	Fuel %			
14	Ng			
15	TOT			
16	Torque %			
17	Annunciators			
18	Digital Clock			
19	Oil Pressure			
20	DME 1 & 2 (VHF, UHF Lo, and 800 MHz)			
21	GPS 1 & 2 (UHF Lo and 800 MHz)			

TECHNISONIC INDUSTRIES LIMITED

STEP	SYSTEM	PASS	FAIL	NOTES
<b>NOTES:</b>				

## APPENDIX A

### SUPPORT NOTES

- For the latest Service Bulletin(s), refer to the Publication Index list under the section for this model (*login required*).
- For the latest Technical Information Bulletins, refer to the Publication Index list under the section for this model (*login required*).
- For the latest Software Release(s), refer to the Publication Index list under the section for this model's software/firmware history index (*login required*).

### ENVIRONMENTAL QUALIFICATION FORM

Model No: TDFM-9100  
Part No: 121270-2-91-ACH/91000  
Description: Airborne Transceiver

Manufacturer: Technisonic Industries Limited  
240 Traders Blvd.,  
Mississauga, Ontario  
Canada  
L4Z 1W7

Tel: 905-890-2113  
Fax: 905-890-5338

Tested to: RTCA / DO-160G (December 8, 2010)  
Date Tested: August 26, 2014 – October 10, 2014  
Test Report No: 14RE515

**TECHNISONIC INDUSTRIES LIMITED**

<b>CONDITIONS</b>	<b>SECTION</b>	<b>CATEGORY</b>	<b>COMMENTS</b>
Temperature and Altitude	4.0	A2, B1, C4, D1	
Low Temperature – Survival	4.5.1		- 55 degrees C
Low Temperature – Short Time Operating	4.5.1		- 40 degrees C
Low Temperature – Operating	4.5.2		- 30 degrees C
High Temperature – Survival	4.5.3		+ 85 degrees C
High Temperature – Short Time Operating	4.5.3		+ 70 degrees C
High Temperature – Operating	4.5.4		+ 70 degrees C
In-Flight Loss of Cooling	4.5.5		not applicable
Altitude	4.6.1		50,000 feet
Decompression	4.6.2		50,000 feet
Overpressure	4.6.3		- 15,000 feet
Temperature Variation	5.0	B	+/- 5 degrees C per minute
Humidity	6.0	A	See NOTE-3
Operational Shock and Crash Safety	7.0	B	Standard Operational Shocks & Crash Safety
Vibration	8.0	S S U	Sinusoidal Vibration – curve M Random Vibration – curve B Sine-On-Random Vibration – curve G
Explosive Atmosphere	9.0	X	Not tested
Waterproofness	10.0	X	Not tested
Fluids Susceptibility	11.0	X	Not tested
Sand and Dust	12.0	X	Not tested
Fungus	13.0	X	Not tested
Salt Fog Test	14.0	X	Not tested
Magnetic Effect	15.0	Z	Distance result was 0.09 meters
Power Input	16.0	B	See NOTE-2, 3
Voltage Spike	17.0	B	See NOTE-3
Audio Frequency Susceptibility	18.0	B	See NOTE-3
Induced Signal Susceptibility	19.0	AC	See NOTE-3
Radio Frequency Susceptibility	20.0	X	Not tested
Radio Frequency Emission	21.0	M	See NOTE-1
Lightning Induced Transient Susceptibility	22.0	X	Not tested
Lightning Direct Effects	23.0	X	Not tested
Icing	24.0	X	Not tested
Electrostatic Discharge	25.0	X	Not tested
Fire, Flammability	26.0	C	Flammability, See NOTE-4
Other Tests			

**Remarks:**

All testing was performed at Technisonic Industries unless otherwise indicated.

NOTE-1 Indicated test was performed by ULTRATECH LABS.

NOTE-2 Testing included subparagraph 16.6.1.3b: Requirement for Equipment with Digital Circuits.

NOTE-3 Approval for this category is based on similarity to the TDFM-9000. See test report 13RE469.

NOTE-4 Only applies to units with "MOD 6" marked on the modifications label.



**TECHNISONIC INDUSTRIES LIMITED**

**NOTES**

**TECHNISONIC INDUSTRIES LIMITED**

**Technisonic Industries Limited**

240 Traders Blvd., Mississauga, ON Canada L4Z 1W7  
Tel: (905) 890-2113 Fax: (905) 890-5338

**IMPORTANT  
WARRANTY**

All communication equipment manufactured by Technisonic Industries Limited is warranted to be free of defects in Material or Workmanship under normal use for a period of one year from Date of Purchase by the end user.

Warranty will only apply to equipment installed by a factory approved and/or authorized facility in accordance with Technisonic published installation instructions. Equipment falling under the following is not covered by warranty:

- Equipment that has been repaired or altered in any way as to affect performance,
- Equipment that has been subject to improper installation,
- Equipment that has been used for purposes other than intended,
- Equipment that has been involved in any accident, fire, flood, immersion, or subject to any other abuse.

Expressly excluded from this warranty are changes or charges relating to the removal and re-installation of equipment from the aircraft. Technisonic will repair or replace (at Technisonic's discretion) any defective transceiver (or part thereof) found to be faulty during the Warranty Period.

Faulty equipment must be returned to Technisonic (or its authorized Warranty Depot) with transportation charges prepaid. Repaired (or replacement) equipment will be returned to the customer with collect freight charges. If the failure of a transceiver occurs within the first 30 days of service, Technisonic will return the repaired or replacement equipment prepaid.

Technisonic reserves the right to make changes in design, or additions to, or improvements in its products without obligation to install such additions and improvements in equipment previously manufactured. This Warranty is in lieu of any and all other warranties express or implied, including any warranty of merchantability or fitness, and of all other obligations or liabilities on the part of Technisonic.

This Warranty shall not be transferable or assignable to any other persons, firms, or corporations.

**For warranty registration, please complete the online  
Warranty Registration Form found at [www.til.ca](http://www.til.ca).**